

# newline



**NT *Series V1.0***

User Manual

# Catalog

---

Catalog.....	2
<b>Symbol Conventions .....</b>	<b>2</b>
<b>Safety Instruction.....</b>	<b>3</b>
<b>1 Parts and Functions.....</b>	<b>6</b>
1.1 Parts .....	6
1.2 Ports.....	8
1.3 Remote Control.....	10
<b>2 Installation Guide .....</b>	<b>13</b>
2.1 Safety Precautions .....	13
2.2 Installation Precautions.....	14
2.3 Installation .....	16
2.4 Installing the Internal PC (Optional).....	17
<b>3 Turning On/Off.....</b>	<b>18</b>
3.1 Power On.....	18
3.2 Power Off.....	19
<b>4 Operating the Intelligent Display .....</b>	<b>20</b>
4.1 Boot-up Screen .....	20
4.2 Initial Setting .....	21
4.3 Welcome page.....	24
4.4 <i>System Setting</i> .....	26
4.4.1 Network .....	26
4.4.2 Language .....	27
4.4.3 Date&Time .....	27
4.4.4 Power Option .....	28
4.4.5 Configuration.....	28
4.4.6 Input.....	29
4.5 Source .....	29
4.6 File Page .....	30
4.6.1 File Preview .....	30
4.6.2 File Management .....	30
4.6.3 File Filtering .....	31
4.6.4 File Search .....	32
4.6.5 File Operation .....	32
4.7 Screen Share .....	33

**5 D. Mode.....34**

**6 Serial Port Control .....35**

**7 Formats Supported by Multi-media .....39**

**8 FAQ & Troubleshooting .....40**

**9 Maintenance Tips.....42**

**10 Technical Parameters.....43**

**11 More Information .....44**

Welcome to the world of **Newline**.

Thank you for choosing the **Newline** NT series Interactive Intelligent Display. Please use this document to get the most out of your screen.

---

This device complies with part 15 of the FCC Rules. Operation is subject to the following two conditions: (1) This device may not cause harmful interference, and (2) this device must accept any interference received, including interference that may cause undesired operation.

NOTE 1: This equipment has been tested and found to comply with the limits for a Class B digital device, pursuant to part 15 of the FCC Rules. These limits are designed to provide reasonable protection against harmful interference in a residential installation. This equipment generates, uses and can radiate radio frequency energy and, if not installed and used in accordance with the instructions, may cause harmful interference to radio communications. However, there is no guarantee that interference will not occur in a particular installation. If this equipment does cause harmful interference to radio or television reception, which can be determined by turning the equipment off and on, the user is encouraged to try to correct the interference by one or more of the following measures:

- Reorient or relocate the receiving antenna.
- Increase the separation between the equipment and receiver.
- Connect the equipment into an outlet on a circuit different from that to which the receiver is connected.
- Consult the dealer or an experienced radio/TV technician for help.

NOTE 2: Any changes or modifications to this unit not expressly approved by the party responsible for compliance could void the user's authority to operate the equipment.

---



The symbol of the crossed out wheeled bin indicates this device should not be placed in municipal waste. Instead, dispose of waste equipment by handing it over to a designated collection point for the recycling of electrical and electronic equipment.



# Symbol Conventions







---

Symbols are used in this document to indicate operations that need particular attention. The symbols are defined as follows:

 <b>NOTE</b>	Provides additional information to supplement operation in the main text.
 <b>CAUTION</b>	Indicates a potentially hazardous situation that, if not avoided, could result in equipment damage, data loss, performance deterioration, or unanticipated results.
 <b>WARNING</b>	Indicates a hazard with risk that, if not avoided, could result in death or injury.

# Safety Instruction

For your safety, please read the following instruction before you use the machine. Serious injury or property damage may be caused by improper operations. Do not try to repair the machine on your own.

 <b>WARNING</b>	
	<p><b>Disconnect the machine from power supply immediately if major failures occur.</b></p> <p>Major failures include the following:</p> <ul style="list-style-type: none"> <li>• Smoke, peculiar smell or abnormal sound is discharged from the machine.</li> <li>• No image or sound is displayed, or the image error occurs.</li> </ul> <p>In the preceding scenarios, do not continue to use the machine. Disconnect power supply immediately and contact professional staff for troubleshooting.</p>
	<p><b>Do not drop liquid, metal or anything combustible into the machine.</b></p> <ul style="list-style-type: none"> <li>• If any liquid or metal is dropped into the machine, power off the machine and disconnect power supply, then contact professional staff for solutions.</li> <li>• Pay attention to children when they are close to the machine.</li> </ul> <p><b>Put the machine on a stable surface.</b></p> <p>An unstable surface includes and does not limited to an inclined plane, a shaky stand, desk or platform, which might cause turnover and damage.</p>
	<p><b>Do not open the cover or change the machine on your own.</b></p> <p>High voltage components are installed in the machine. When you open the cover, high voltage, electric shock, or other dangerous situations may occur.</p> <p>If inspection, adjustment, or maintenance is required, contact the local distributor for help.</p>
	<p><b>Use the specified power supply.</b></p> <ul style="list-style-type: none"> <li>• To prevent the machine from being damaged, do not use any types of power cables other than the one provided with the machine.</li> <li>• Use a three-wire socket and ensure that it is properly grounded.</li> <li>• Pull out the power plug from the socket if the machine is not used for a long period.</li> </ul> <p><b>Clean the dust and metal on the power plug regularly.</b></p> <ul style="list-style-type: none"> <li>• Fire or electric shock may be caused if the machine is powered on, when you are cleaning.</li> <li>• Pull out the power plug before cleaning it with a dried cloth.</li> </ul>
	<p><b>Do not put items on the top of the machine.</b></p> <ul style="list-style-type: none"> <li>• Do not put items, such as a container for liquid (a vase, flowerpot, cosmetics or liquid medicine) on the top of the machine.</li> <li>• If any water or liquid is spilled on the machine, a short circuit may occur and cause fire or electric shock.</li> <li>• Do not walk on or hang any items on the machine.</li> </ul>



## WARNING

	<p><b>Do not install the machine in an improper place.</b></p> <ul style="list-style-type: none"><li>• Do not install the machine in humid places, such as the bathroom, the shower room, near windows, or outdoor environments that experience rain, snow or other harsh weather. Avoid installation near hot spring vapor. The preceding environments may cause faults in the machine or electric shock under extreme conditions.</li><li>• Do not put exposed fire source, such as an ignited candle, on the machine.</li></ul>
	<p><b>Pull out the power plug during thunderstorms.</b></p> <ul style="list-style-type: none"><li>• Do not touch the machine during a lighting storm to avoid electric shock.</li><li>• Install or place components that supply high enough voltage to cause personal injury out of the reach of children.</li></ul>
	<p>Do not touch the power cable with wet hands.</p>



## CAUTION

	<p><b>Do not install the machine in high temperature environments.</b></p> <ul style="list-style-type: none"><li>• Do not install the machine near a heat source, such as a radiator, a heat reservoir, a stove or other heating machines.</li><li>• Do not expose the machine to direct sunlight, which may cause high temperatures and subsequent faults in the machine.</li></ul>
	<p><b>For transport:</b></p> <ul style="list-style-type: none"><li>• Pack the machine for transport or maintenance by using the cartons and cushioning material provided with the machine.</li><li>• Vertically move the machine during transport. The screen or other components are easily broken if the machine is moved by an improper way.</li><li>• Before you move the machine, disconnect all external connections and separate all toppling preventing machines. Move the machine carefully to prevent it from being hit or squeezed, especially the screen, which may cause injury if broken.</li></ul>
	<p><b>Do not cover or block up any vents on the machine.</b></p> <ul style="list-style-type: none"><li>• Any overheated components may cause fire, damage the machine, and shorten the service life.</li><li>• Do not lay the machine down where the venting surface will be covered.</li><li>• Do not install the machine on a carpet or cloth.</li><li>• Do not use a cloth such as table cloth to cover the machine.</li></ul>
	<p><b>Keep away from the machine when you use a radio.</b></p> <p>The machine complies with the international EMI standard to prevent radio interference. However, interference may still exist and causes noise in the radio. If noise occurs in the radio, try the following solutions.</p>



## CAUTION

- Adjust the direction of the radio antenna to avoid the interference from the machine.
- Keep the radio away from the machine.

### **Use the battery correctly.**

- Galvanic corrosion, electric leakage, and even fire may be caused by improper battery usage.
- It is recommended to use the designated type of battery and install the battery by correct electrodes (positive and negative).
- Do not install and use new battery with a used one.
- Take out the battery if the remote control is not used for a long period.
- Do not expose the battery to overheated environments such as sunlight and firing.
- Dispose of the used battery based on your local regulations.

### **Do not damage the power cable.**

- Do not damage, change, twist, bend, or forcibly drag the power cable.
- Do not put weights (such as the machine itself) on the power cable.
- Do not forcibly drag the cable when you pull out the power plug. If the power cable is damaged, please contact the local distributor to repair or replace it.
- The power cable in the accessory box is for this machine only. Do not use it on other machines.

### **Additional advice:**

- Use the machine in an environment with comfortable lighting. It is harmful to your eyes to watch in a too bright or too dark environment.
- Relax your eyes after a period of time for watching.
- Keep sufficient distance from the machine to protect your eyes and prevent eyestrain.
- Adjust the volume to an appropriate level, especially at night.
- Use amplifier equipment as the audio input source with caution. If you must use amplifier equipment, the input power should not exceed the maximum of speaker power. Otherwise, the speaker can become overpowered and damaged.

### **About USB port.**

- Rear USB 3.0 ports switch connections based on signal sources. If the current signal source is reading the data from an external machine connecting to the port, please switch the signal source after the data reading is complete. Otherwise, the data or machine may be damaged.



# 1 Parts and Functions

---

## 1.1 Parts

- Front View

TT-8519NT:



TT-9819NT:



- Rear View

TT- 8519NT:

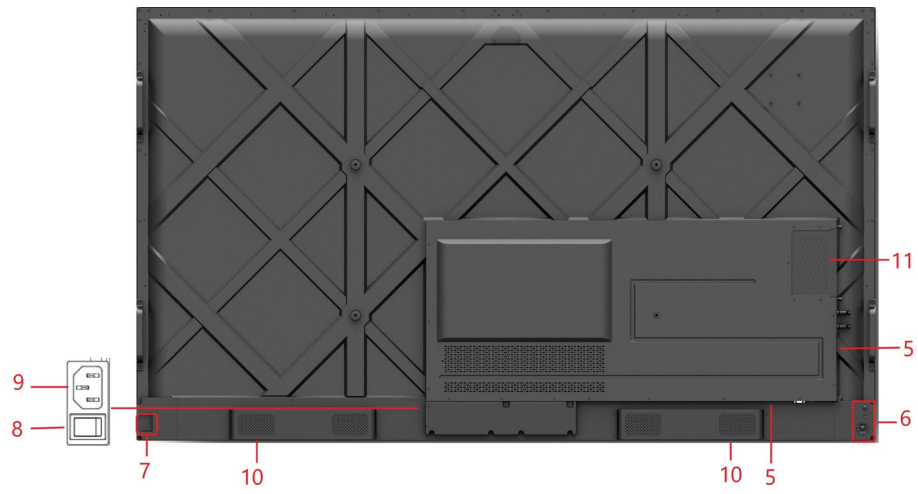

TT- 9819NT:

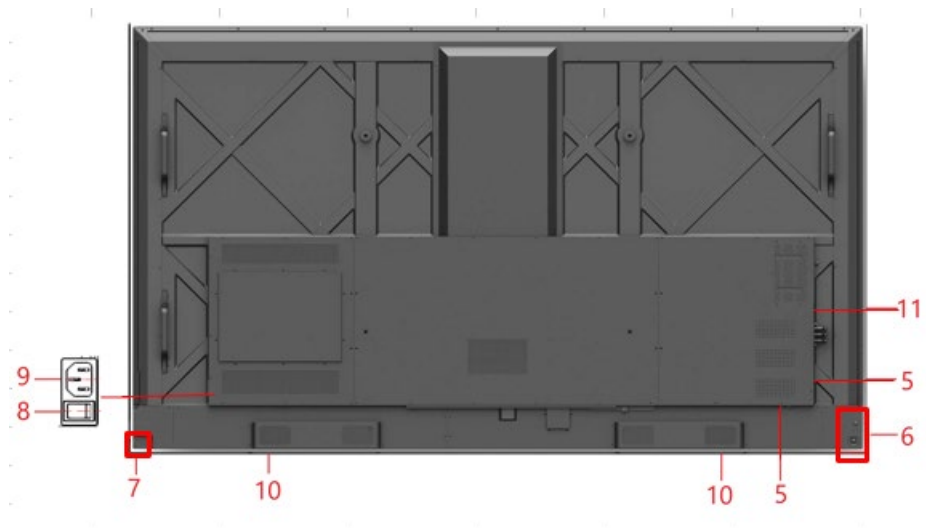

1	MIC	7	USB3.0
2	Power On/Off	8	Power Switch
3	Remote Control Receiver	9	Power Supply Plug
4	Light sensor	10	Speakers
5	Rear Ports	11	Internal PC Port
6	Rear Buttons		

# 1.2 Ports

- Front Buttons



Buttons	Operations	Functions
	Short press	Power on/Sleep mode
	Long press(3 seconds)	Power off

- Rear Ports



## CAUTION

*Rear USB 3.0 ports switch connections based on signal sources. If the current signal source is reading the data from an external machine connecting to the port, please switch the signal source after the data reading is complete. Otherwise, the data or machine may be damaged.*

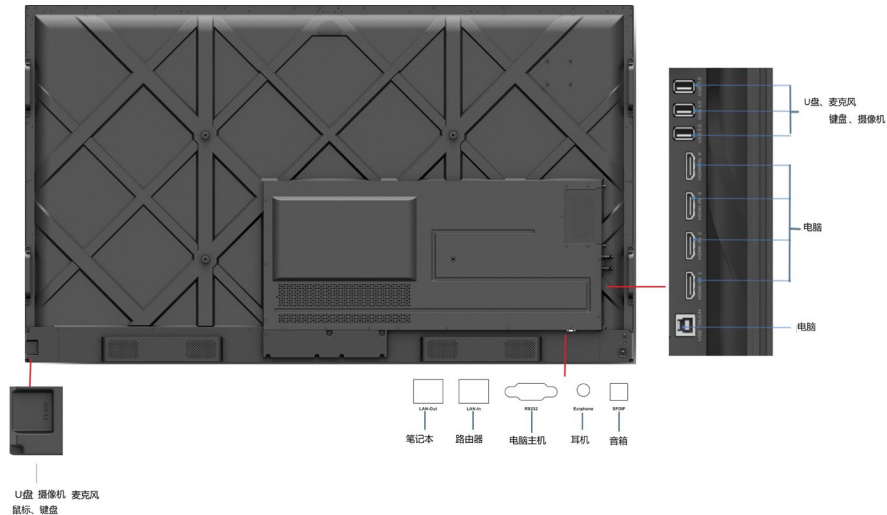

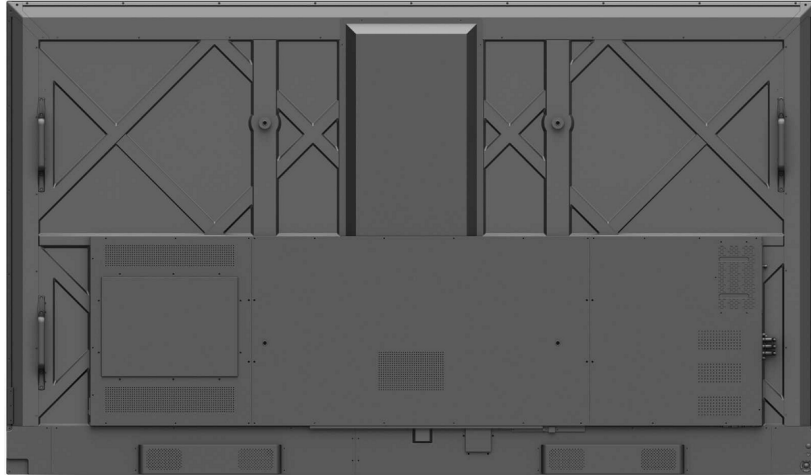



 **NOTE**

- When using the 2.4G wireless mouse, we recommend using the USB port on the lower right side of the back panel.
- Please do not connect a 2.4G wireless mouse and USB 3.0 devices simultaneously, on the left side of the back panel, in order to avoid the interference.

- Rear Buttons



Buttons	Operations	Functions
MENU	Short press	Open/Exit the system menu
	Short press	Return to Previous/Exit
ok	Short press	Confirm/OK
	Short press	Up/Down/Left/Right

## 1.3 Remote Control









Carefully read the following instructions before using the remote control to avoid possible faults:

- Do not drop or damage the remote control.
  - Do not spill water or other liquids on the remote control.
  - Do not place the remote control on a wet object.
  - Do not place the remote control under direct sunlight or near an overheating heat source.
-



Buttons	Operations
	Power On/Off
	Mute/Unmute Audio
Home	Enter Home source
	Open the system menu
	Return to Previous/Exit
	Up/Down/Left/Right
	Confirm/OK
	Mouse left Button: pointing, clicking, etc. Please enable the mouse then use it.
Mouse Mode	Open/turn off the wireless mouse mode

Buttons	Operations
	Mouse Right Button: click to exit Android app. Please enable the mouse mode then use it.
	Switch back light mode
	Mute/Unmute Microphone
	Short Press: Increase the sound volume Long Press: Increase the sound volume continuously
	Short Press: Decrease the sound volume Long Press: Decrease the sound volume continuously
	Freeze the Current Screen, Click Again to Exit Freeze Function
	Enable Sound Only Mode, Click Again to Exit the mode
keyboard	An input device of the display, it can input English letters, Numbers, punctuation, etc.

# 2 Installation Guide

---

## 2.1 Safety Precautions

### Installation Environment





## Installation Direction

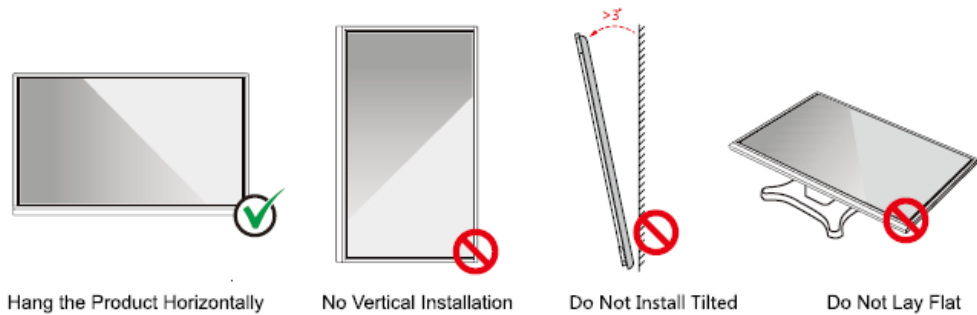

## 2.2 Installation Precautions

### Weight Loading

Weight of the machine:

TT-8519NT net weight 46.5 kg( $\pm 2$ kg);

TT-9819NT net weight 84.0 kg( $\pm 2$ kg).

- When using a mobile stand, ensure that the weight of the machine is less than the loading capacity of the mobile stand.
- When using the wall-mount bracket, ensure that the wall can support the weight of the machine. We recommend that the wall surface be reinforced and have a loading capacity 4 times of the weight of the machine. Consult a professional installer for wall-mount installation.

#### NOTE

- *The company does not undertake relevant legal responsibility for any problems caused by improper operation, if the third party mobile stand, or wall-mount bracket is beyond the scope of the machine.*
- *Do not install the machine where it might be hit by a door.*

### Vertical installation

When installing, try to keep the machine vertical. The vertical tilt range allowing for wall-mount installation is  $\pm 3$  degrees. Excessive tilt angle may cause the screen glass to fall off or the machine to collapse.

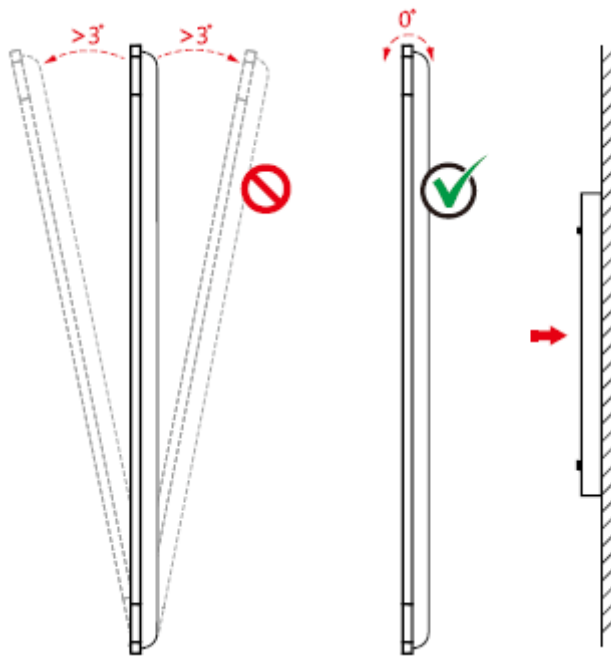

**NOTE**

*For any problem, please contact our support desk. Our company is not responsible for any damage or losses incurred by users if the users fails to follow the instructions.*

**Ventilation**

Ensure adequate ventilation and/or air conditioning environment. We recommend keeping certain distances from the side of the machine to the wall or panels. Ventilation requirements are shown in following figure.

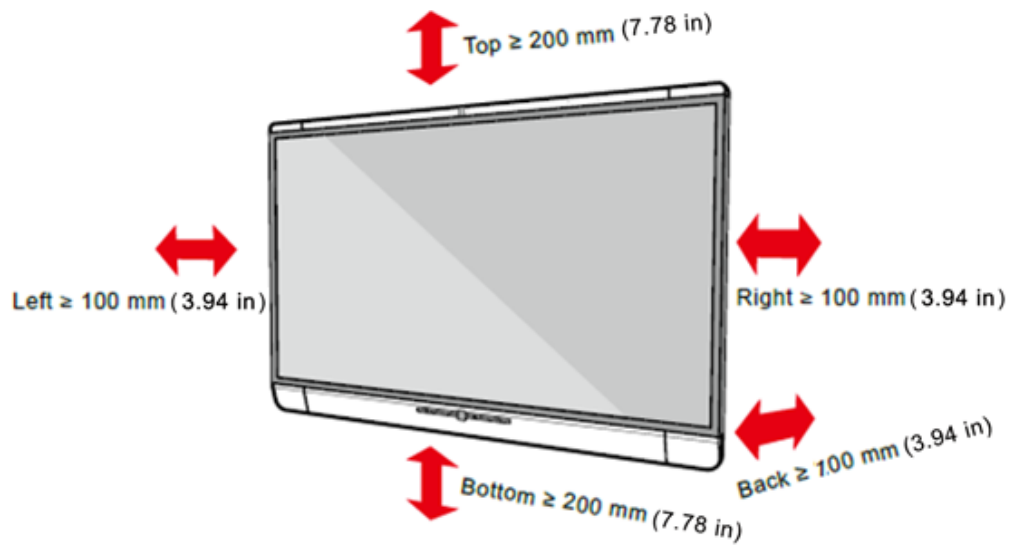

## 2.3 Installation

The dimensions of the four bracket mounting holes on the back panel are VESA MIS-F compliant (TT-8519NT: 800 x 400 mm/31.50 x 15.75 in; TT-9819NT: 800 x 600 mm/31.50 x 23.62 in). Use metric M8 screws with length of 10 mm to 15 mm (0.40 to 0.59 in) to secure the machine with the mounting system. Dimensions of the mounting holes on the back panel are shown on the following figure.

 **NOTE**

*Consult a professional installer to install the machine.*

85"

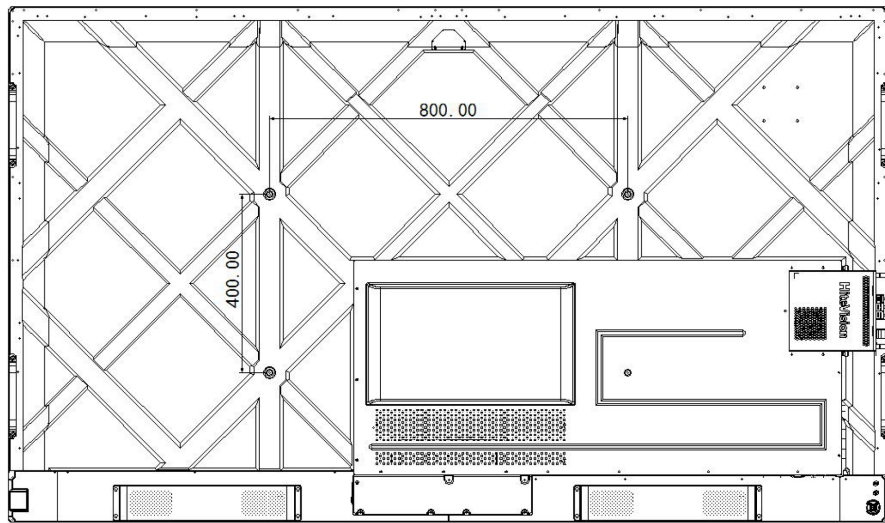

98"

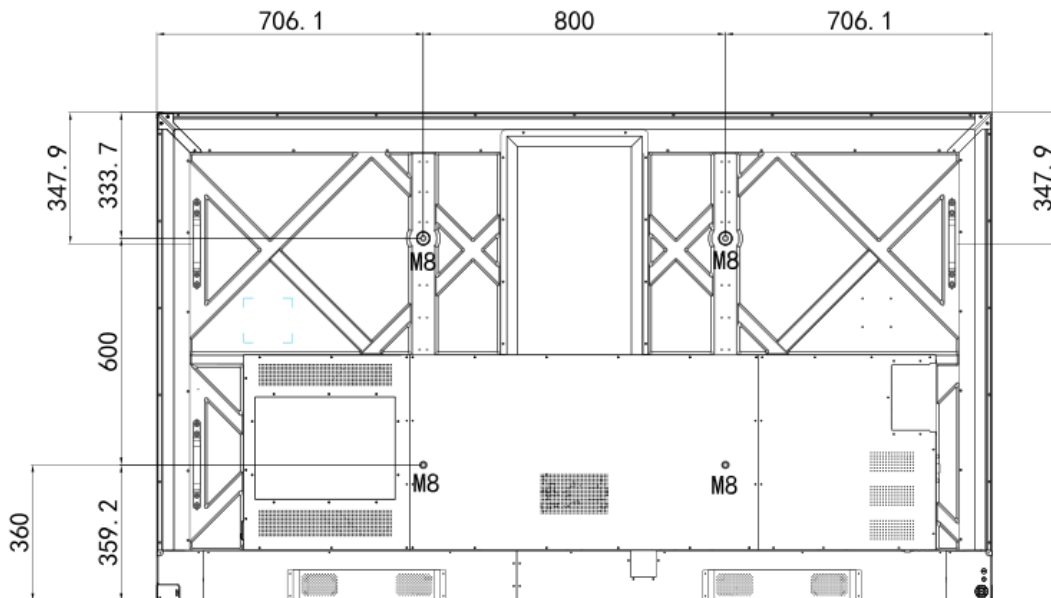

## 2.4 Installing the Internal PC (Optional)



*The internal PC does not support hot plugging. Therefore, you must insert or remove it when the machine is powered off. Otherwise, the machine or internal PC may be damaged.*

---

You will need to purchase the internal PC separately. Perform the following steps to install the internal PC.

**Step 1** Unscrew the M3 screws by hand to remove the internal PC shielding cover.

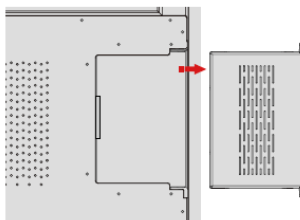

**Step 2** Push the internal into the internal PC port at the rear of the machine from right to left.

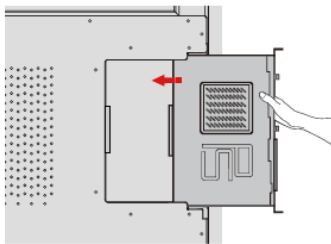

**Step 3** Secure the internal PC to the display by using the M3 screws.

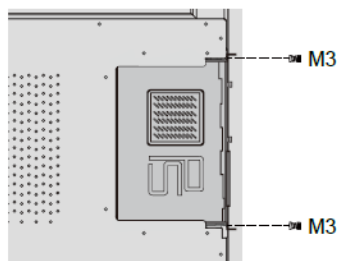

**Step 4** Ensure the installation is correct before turning the power on again.

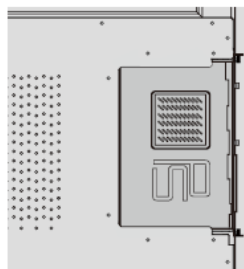

# 3 Turning On/Off

---

## 3.1 Power On

**Step 1** Plug the power supply into the power outlet fully and plug the power connector into the side of the machine. Ensure the power is in the range of 100 V to 240 V with frequency at 50 Hz/60 Hz  $\pm$  5%. The power current must be grounded.





**NOTE**

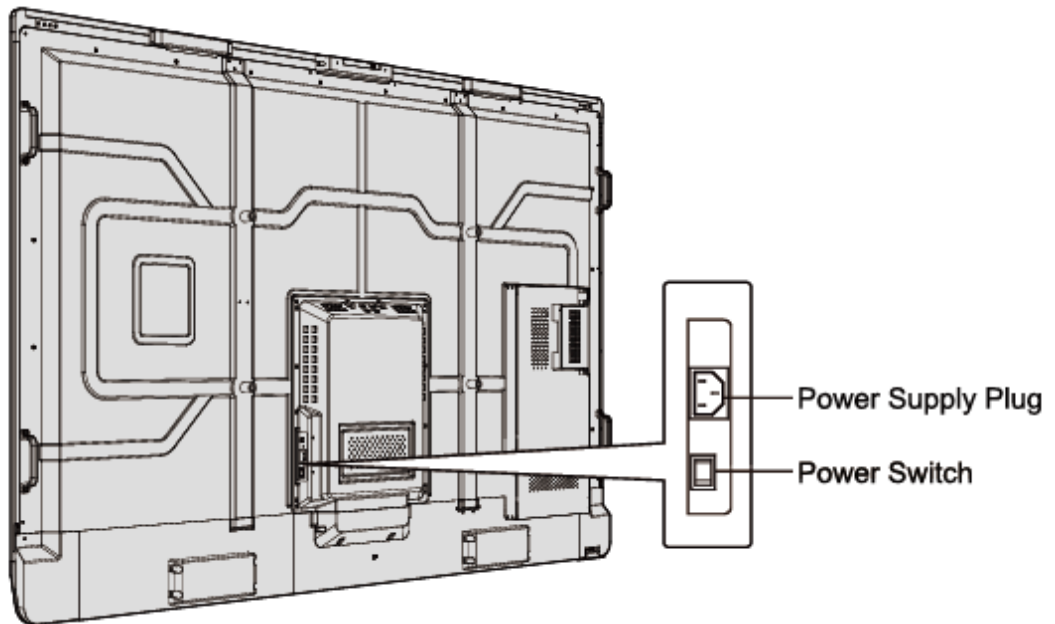

*The power outlet should be installed near the machine and shall be easily accessible.*

**Step 2** Flip on the power switch located on the side of the machine to “On”.



**Step 3** Press the power button  on the front control panel or  on the remote control.

## 3.2 Power Off

**Step 1** Long press the power button  on the front panel or press the power button  on the remote control, the power indicator will turn to red.

**Step 2** If you are not going to use the machine for an extended period of time, we recommend you to switch the power switch to “Off”



### **NOTE**

- If an internal PC is equipped, the internal PC and the screen are powered off simultaneously when you power off the system.
- Do not forcibly disconnect the power supply of the machine when the internal PC is on.

# 4 Operating the Intelligent Display

---

## 4.1 Boot-up Screen



When the machine is turned on, the machine screen will show the boot-up page. As shown in the following figure.



## 4.2 Initial Setting

When starting up for the first time, the system automatically enters the initial setup interface, as the following steps:

### Step 1 Language Choice:

Press the Up and Down button on the remote control or on the rear control panel to select the language you want, then press the button  on the remote control, or press the button  on the rear control panel to make a confirm, when the “OK” icon in the interface highlight, press the confirm button again to enter next step.

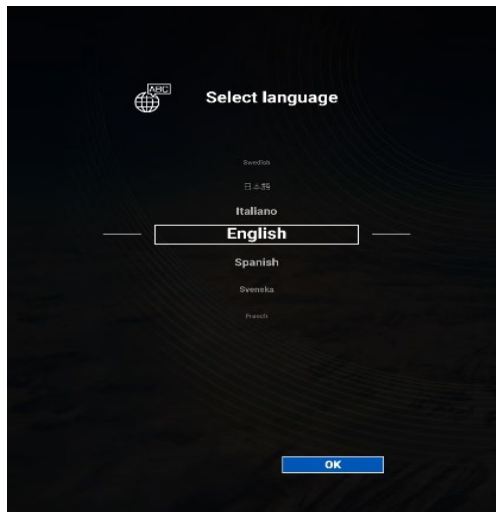

### Step 2 Welcome Page

The welcome page show as in the following figure. Choose OK to enter the next step; Choose Skip to enter the Home Page straightly.

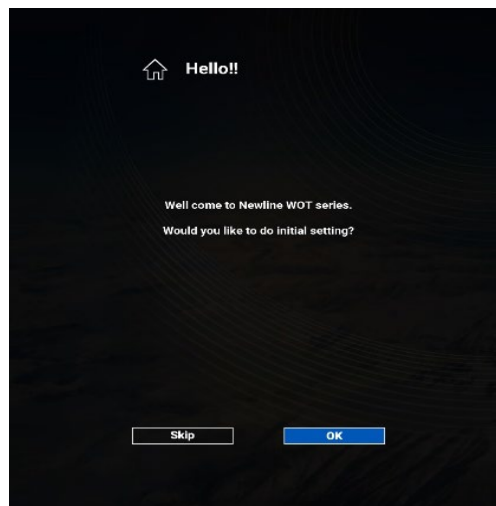



### Step 3 Network Settings

Press the Up and Down button on the remote control or on the rear control panel to select the network you want, then choose OK to make a confirm; or choose Skip to enter the next step straightly.

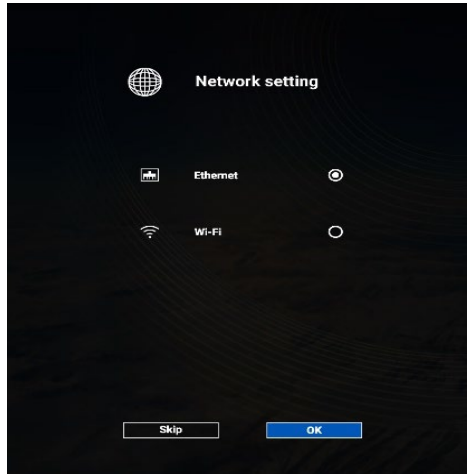

#### NOTE

Ethernet is defaulted by the system.

### Step 4 System Update

If automatic update is detected by the system, the prompt page appears as following figure; Choose More Information to view more updates details; Choose OK to start update; Choose Skip to enter the next step straightly.

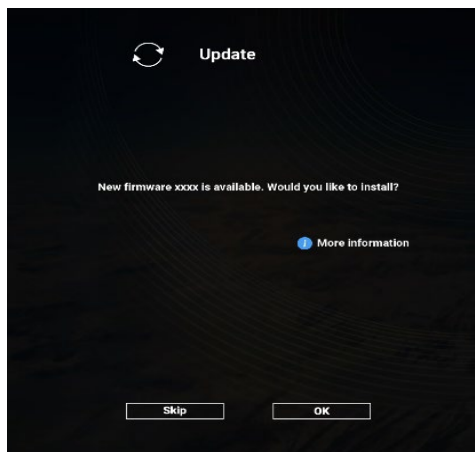

### Step 5 Import

You can use USB flash memory to import the setting data to the machine. Choose OK to start the import; Choose Skip to enter the next step straightly.

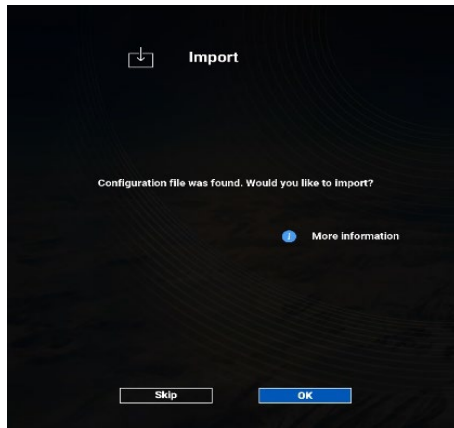

 **NOTE**

If no USB flash memory, or no import file in it, system will enter to the next step straightly.

**Step 6** Complete The Setting

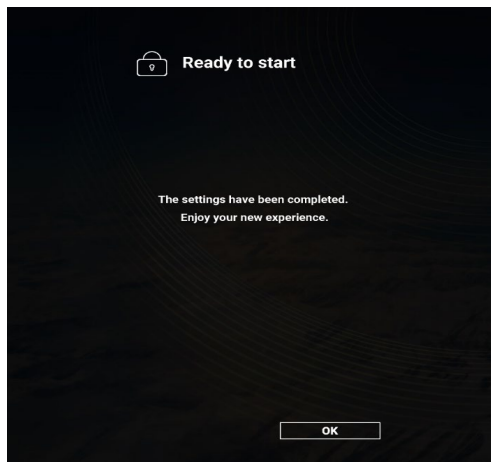

Choose OK to enter the Home Page.

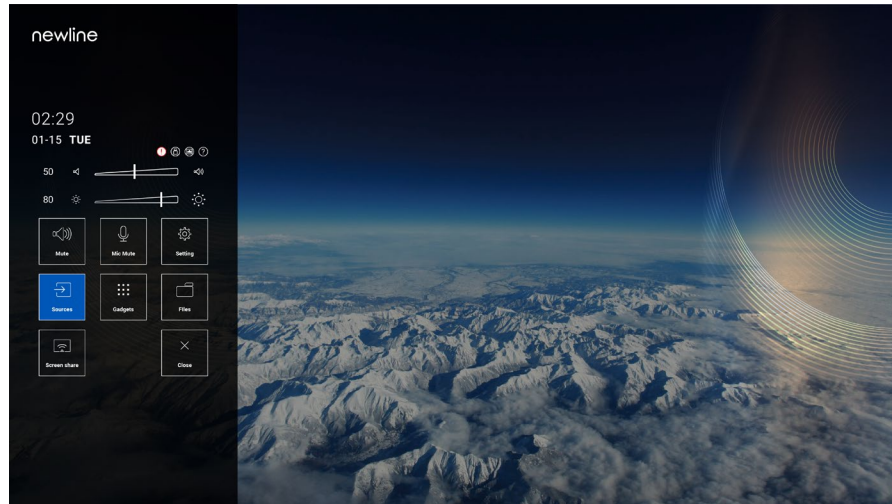

## 4.3 Welcome page

After setting, the system enter the welcome page and you will see the menu interface in the left side. The menu items include **Mute**, **Mic Mute**, **Setting**, **Sources**, **Gadgets**, **Files**, **Screen Share** and so on, as shown in the following figure:





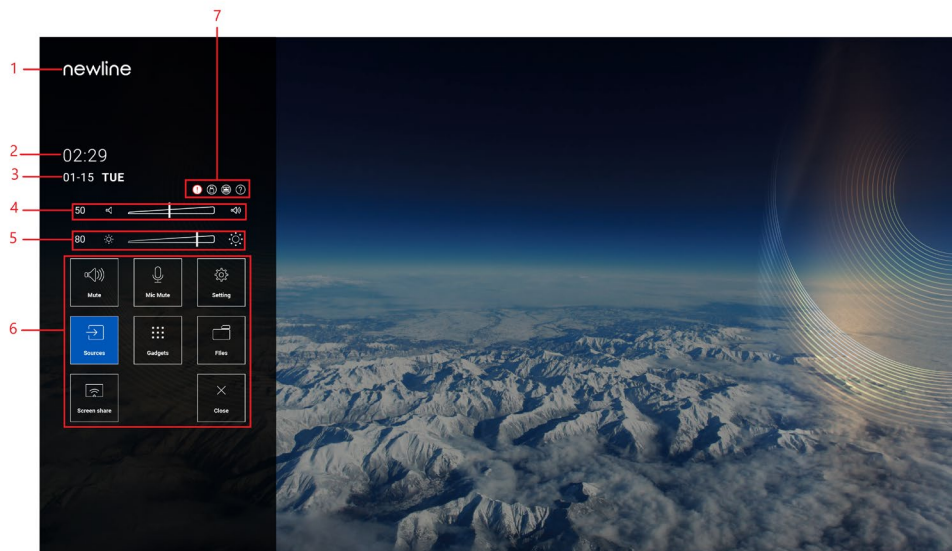

Press ◀/▶/▲/▼ on the remote control to select a menu item, press ✓ to complete the menu switching and option setting in the menu. If you don't want the menu page, you can press the menu button  on the remote control or the button  on the rear control panel, then the machine will exit the menu page.









- 1: Logo
- 2: Clock (Shortcut to Clock)
- 3: Date and Week
- 4: Adjust the Sound Volume
- 5: Adjust the Brightness
- 6: Main Icon
- 7: Status Bar

## Status Bar

Icon	Functions
	When there is an update, choose it to enter the OTA update process.
	When there is an USB memory detected, choose it to enter the file viewer.
	Display the current state of the network. If Wi-Fi and LAN are connected at the same time, LAN is preferred. You can choose it to enter the network setting.
	Tutorial icon. When this icon is highlighted, you can see the function guide of every icon.

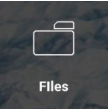
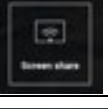
## Main Icon

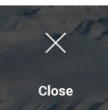
Icon	Functions
	Mute/Unmute Audio
	Mic Mute/Unmute
	Click Connection to view the connected sources, including Internal PC, HDMI 1, HDMI 2, HDMI3, HDMI4.
	Gadget displays all pre-installed applications.
	Open the File viewer, and you can explore on internal and external files of the screen.
	Click the icon to enable the wireless screen sharing function.
	Click the icon to access the system setting page.
	Click the icon to close the menu.

## 4.4 System Setting

Select the **Setting** item to enter the system setting interface, this interface displays **Mute**, **Mic Mute**, **Network**, **Language**, **Date & Time**, **Gadgets**, **Storage** and so on options. You can select the corresponding option to set as



needed. Select “**Back**” to exit the system setting interface.

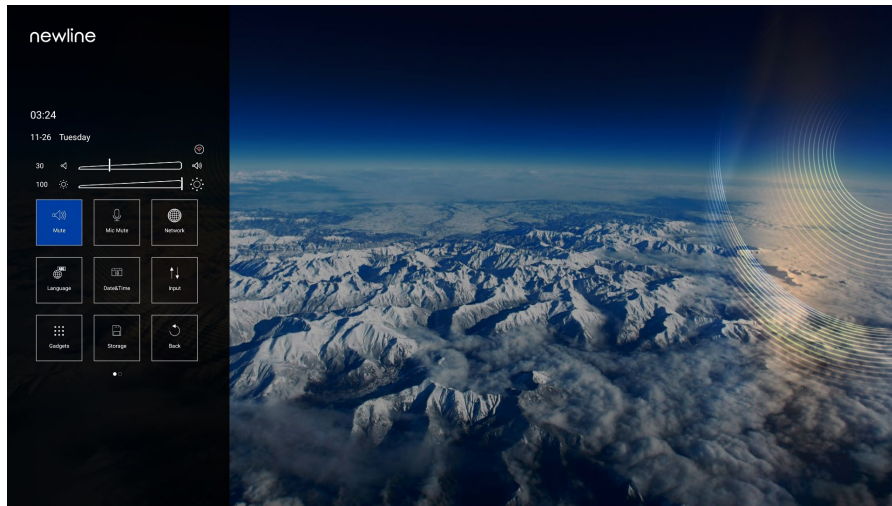

### 4.4.1 Network

Select **Network** to enter the network setting interface. You can view network status information, set **Ethernet**, **Wi-Fi**, **Hotspot & tethering** and **Proxy**. Press  button on remote control to return to the upper interface.

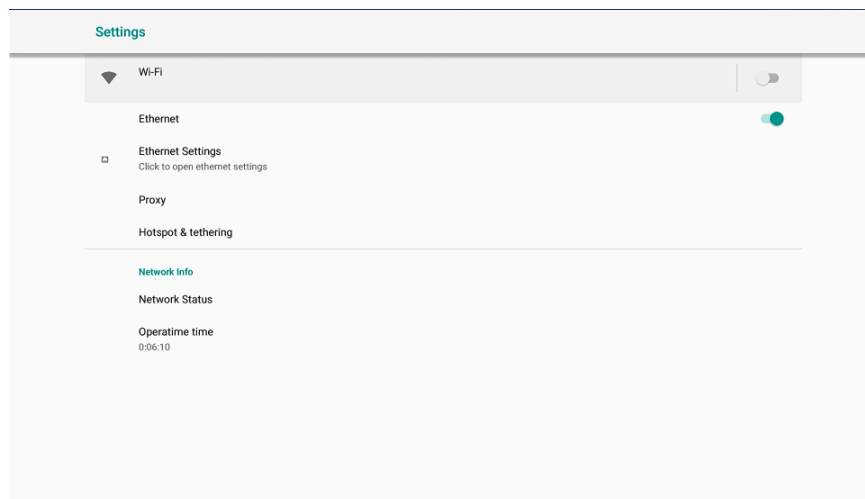

## 4.4.2 Language

Select **Language** to enter the setting interface of language. You can set **Language**, **Keyboard& inputs** method in this interface. Press  button on remote control to return to the upper interface.

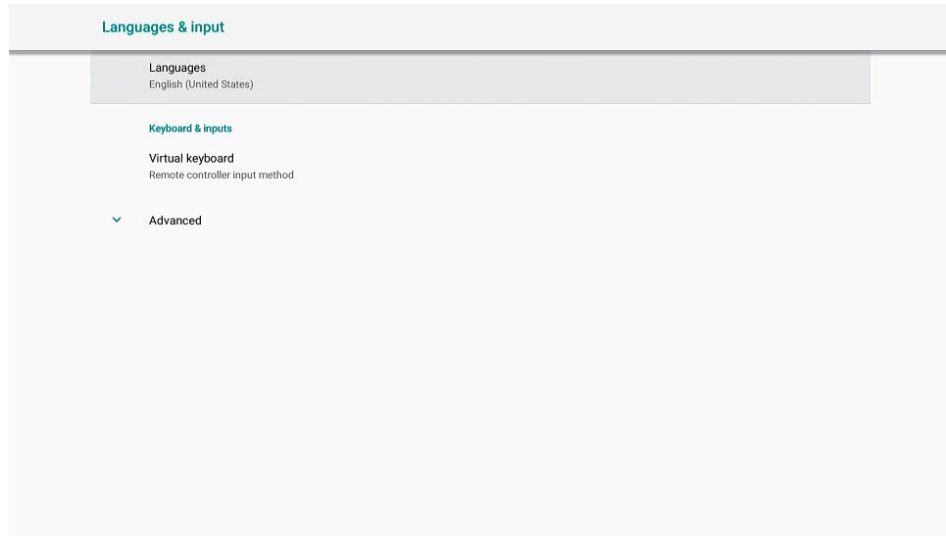

## 4.4.3 Date & Time

Select **Date &Time** to enter the setting interface of Date &Time. You can set **automatic date &time**, **hour format**, **date format**, **select time zone** in this interface. Press  button on remote control to return to the upper interface.

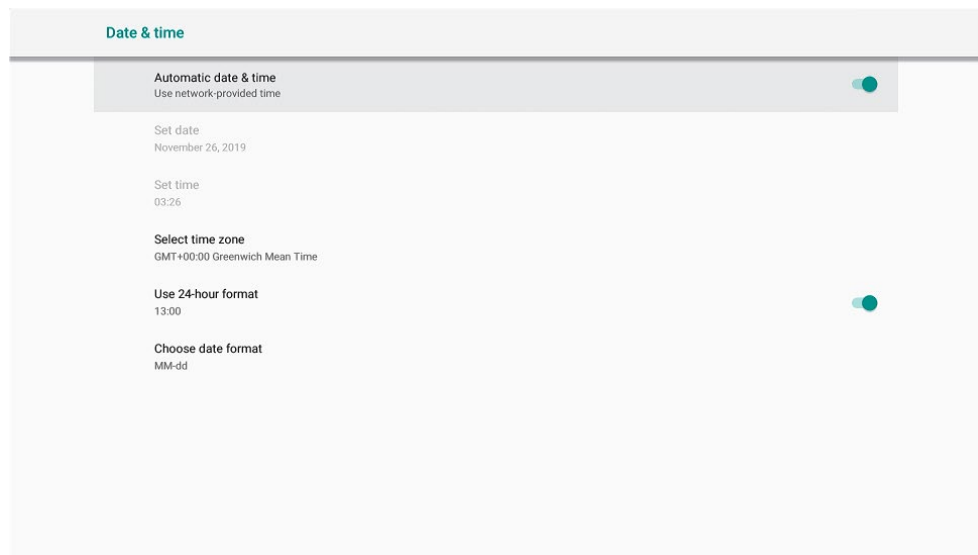

## 4.4.4 Power Option

Select **Power Option** to enter the setting interface of power option. You can set **Sleep mode**, **Energy Saving**, **Eye protection brightness control mode** in this interface. Press  button on remote control to return to the upper interface.

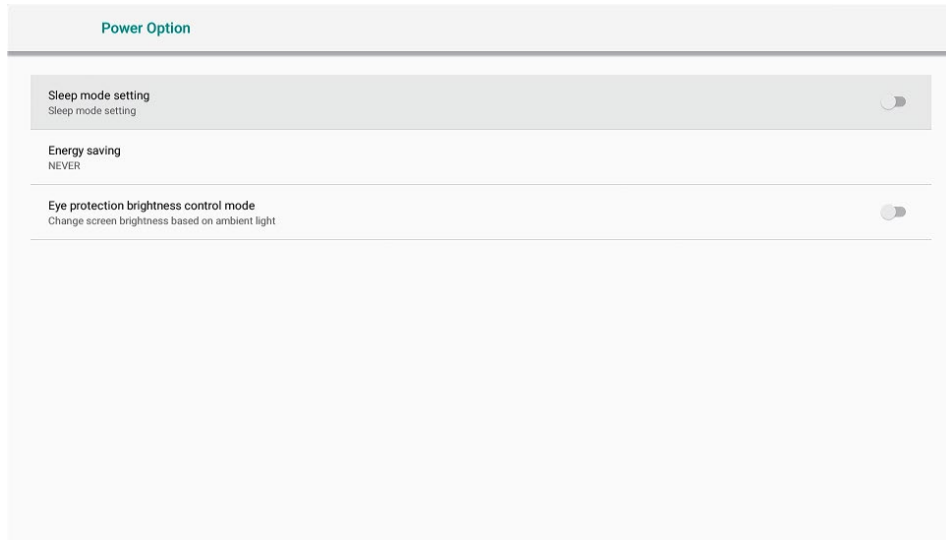

## 4.4.5 Configuration

Select **Configuration** to enter the setting interface of configuration. You can set **Image mode**, **Display mode** in this interface. Press  button on remote control to return to the upper interface.

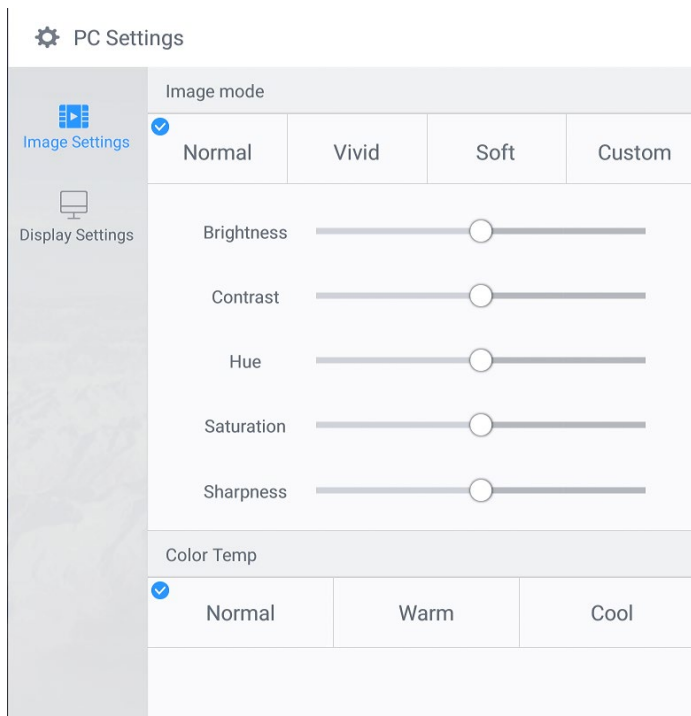

## 4.4.6 Input

Select **Input** to enter the setting interface of input. You can set **Starting Source**, **New Input Source** in this interface. Press  button on remote control to return to the upper interface.

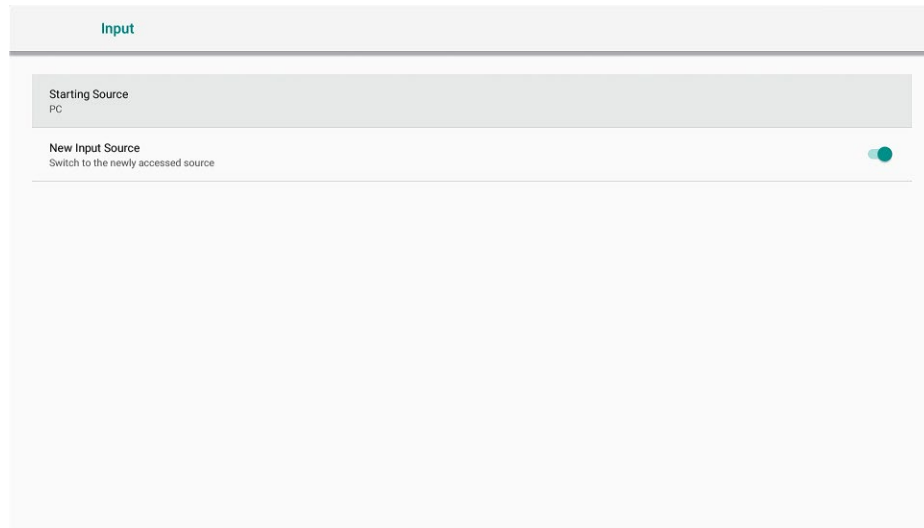

## 4.5 Source

Select the **Source** item in the menu to enter the source interface, you can preview all the source options in this interface, and choose the source as you needed.

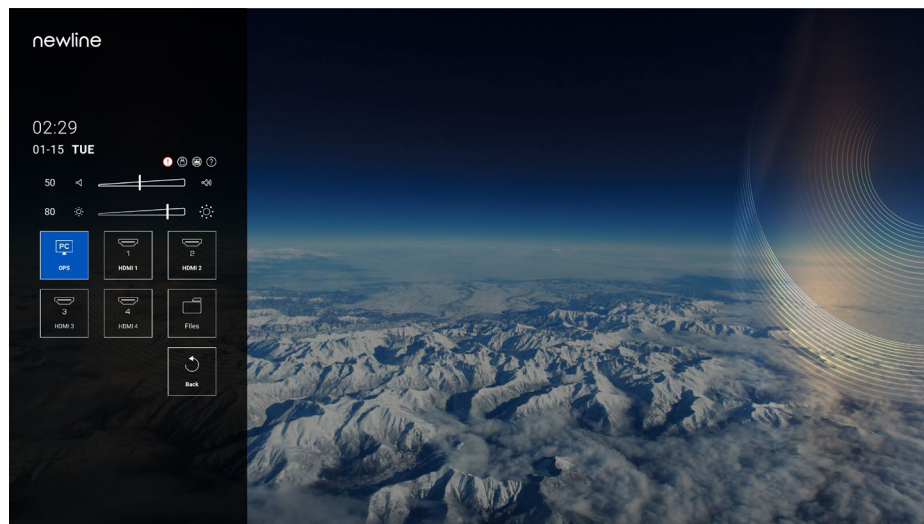



## 4.6 File Page

On the **Menu** page, click **File**, as shown in the following figure

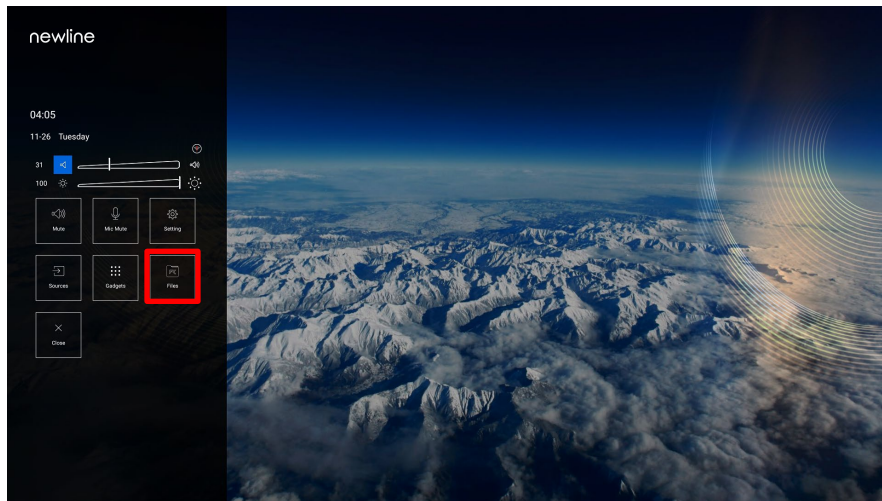

### 4.6.1 File Preview

Enter the **Files** application, you can click the submenu at the left side according to requirements, preview internal storage, external storage devices connected via the USB ports, cloud stored files, FTP uploaded files, and local network files, as shown in the following figure.

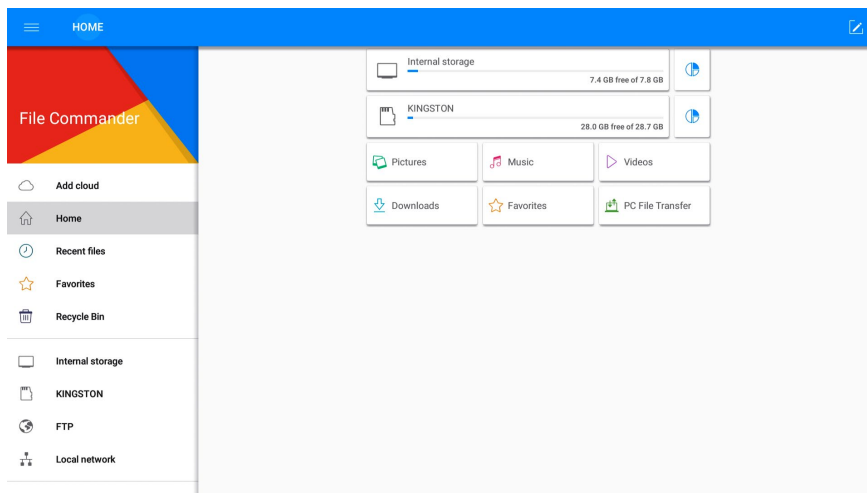

### 4.6.2 File Management

The machine supports connection to USB flash memory. Enter the File application, you can preview all files in the internal storage and storage devices connected via USB ports and select, copy, paste, delete and search for files.

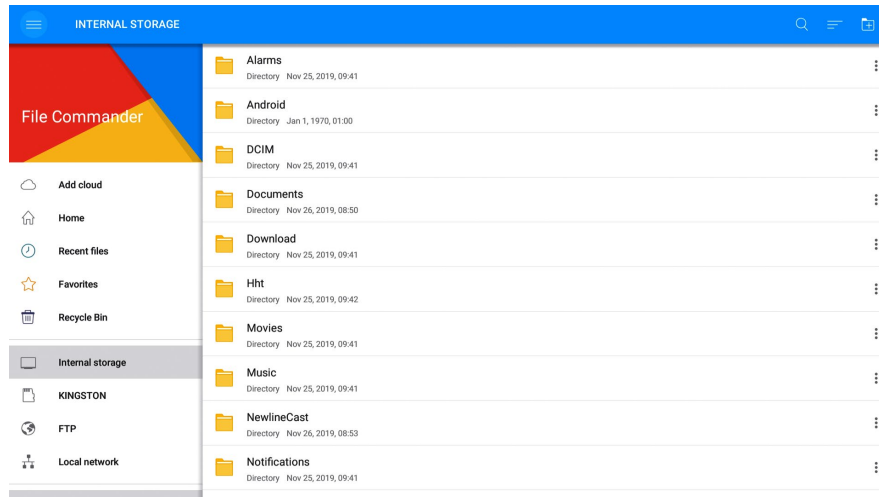

### 4.6.3 File Filtering

You can click the menu at the left side to display files by types, for example: **Documents, Pictures, Music, Videos, Archives and Downloads.**

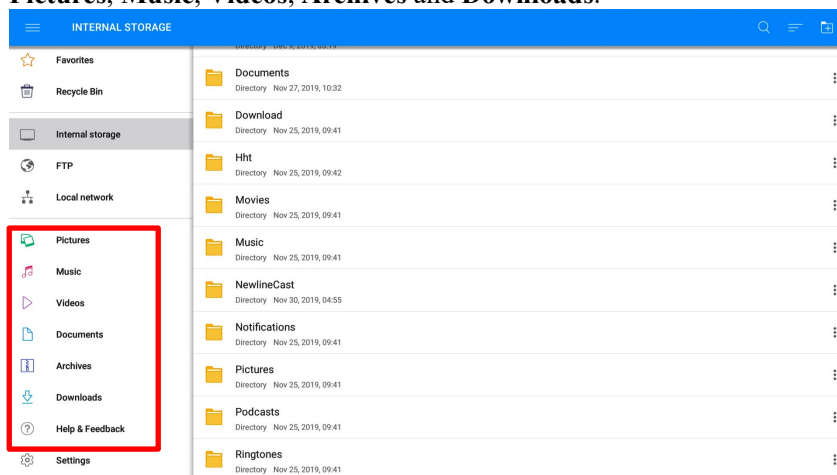

You can also click  at the top right corner to filter files by **View mode, Sort by, show only.**

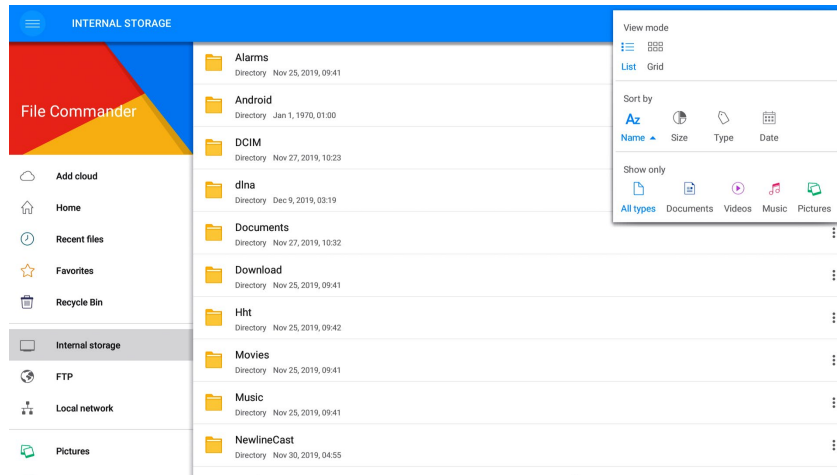

## 4.6.4 File Search

Enter the **Files** application and click  in the dialog box that is displayed, enter keywords in the search box according to requirements. The system will display a list of files that match the keywords.

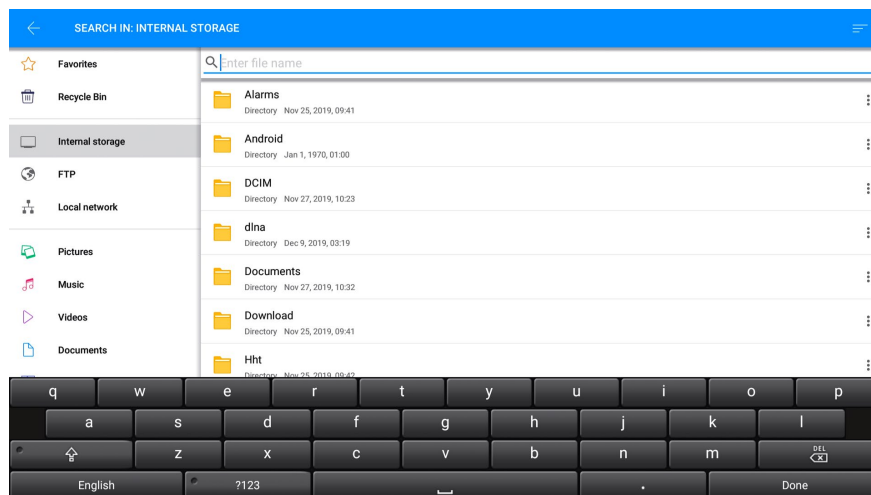

### NOTE

- Use the keyboard on remote control to enter keywords.
- Use mouse function of remote control to click the soft keyboard on screen to enter keywords.

## 4.6.5 File Operation

Enter the **Files** application. You can create folders according to requirements, select files, and set **rename/move/copy/cut/delete/open as/share/zip**. For details on other operation, click  in the right side for more operation.

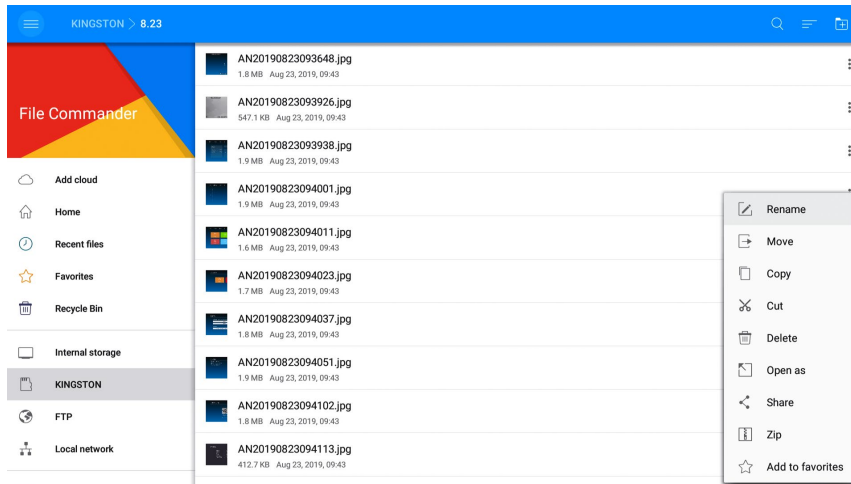

 **NOTE**

After entering the files interface, select the file items using the mouse function of remote control.

## 4.7 Screen Share

Multiple devices can be cast wirelessly to the display through several casting modes (Airplay, Chrome Browser, or Displaynote windows software etc.).

To cast: click **Screen Share** on the menu page to enter screenshare. On screen directions will appear for you to follow in order to wirelessly cast to the display, as shown in the following figure:

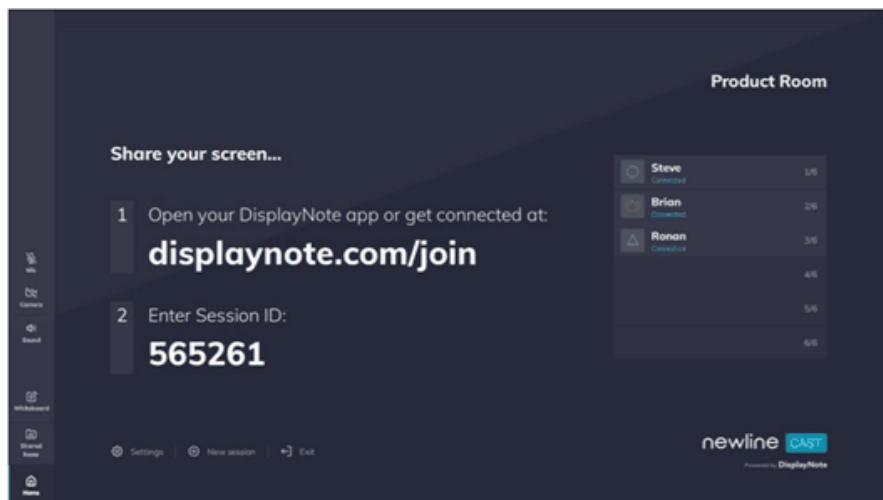

# 5 D. Mode

---



## CAUTION

- *Please switch off the panel when it is not used and enable the function of sound only when you do not need to watch the display, which help reduce power consumption and save energy.*
  - *On the premise of ensuring viewing effect, the energy consumption can be reduced by lowering display brightness.*
- 

Press **D. MODE** on the remote control to enter the **D. Mode (Standard – Eco – Custom - Auto)**. Hold the button to switch between the four modes.

- In the **Standard** mode, the screen brightness keeps the same.
- In the **Eco** mode, the **screen brightness** is reduced 60%.
- In the **Custom** mode, the **screen brightness** is reduced 20%, (Support manual adjustment, the device will memory the brightness after adjustment).
- In the **Auto** mode, the **screen brightness** is reduced 20%, (If the eye protection brightness control mode is turned on, it will change automatically according to the ambient light).

# 6 Serial Port Control

The RS-232 port of the machine is defined as follows

PIN	Local	PC
1	NC	NC
2	RXD0	TXD0
3	TXD0	RXD0
4	NC	NC
5	GND	GND
6	NC	NC
7	NC	NC
8	NC	NC
9	NC	NC
Shell	GND	GND

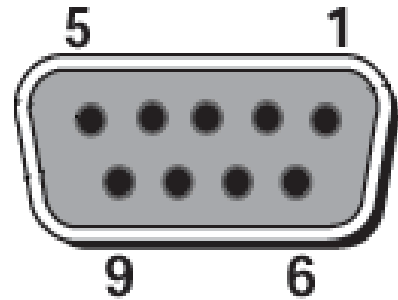

Connect RS-232 port to the PC or controlling device. Enable RS-233 serial port connection and complete the following configuration

Port: COM1 (Set according to PC or controlling device's port number)			
Baud rate	9600/19200/38400/15200	Odd/even check	None
Data bits	8	Stop bit	1

The following table lists button controlling codes. The buttons share same functions with corresponding buttons on the remote controller:

Controlling codes		
Function	Controlling codes	Return codes
Power on	7F 08 99 A2 B3 C4 02 FF 01 00 CF	7F 09 99 A2 B3 C4 02 FF 01 00 01 CF
Power off	7F 08 99 A2 B3 C4 02 FF 01 01 CF	7F 09 99 A2 B3 C4 02 FF 01 01 01 CF
Mute/Unmute toggle	7F 08 99 A2 B3 C4 02 FF 01 02 CF	7F 09 99 A2 B3 C4 02 FF 01 02 01 CF
Mute On	7F 09 99 A2 B3 C4 02 FF 0F 00 CF	7F 09 99 A2 B3 C4 02 FF 0F 00 01 CF
Mute Off	7F 09 99 A2 B3 C4 02 FF 0F 01 CF	7F 09 99 A2 B3 C4 02 FF 0F 01 01 CF
Display status	7F 08 99 A2 B3 C4 02 FF 01 09 CF	7F 09 99 A2 B3 C4 02 FF 01 09 01 CF
OPS	7F 08 99 A2 B3 C4 02 FF 01 38 CF	7F 09 99 A2 B3 C4 02 FF 01 38 01 CF
HDMI rear 1	7F 08 99 A2 B3 C4 02 FF 01 52 CF	7F 09 99 A2 B3 C4 02 FF 01 52 01 CF
HDMI rear 2	7F 08 99 A2 B3 C4 02 FF 01 53 CF	7F 09 99 A2 B3 C4 02 FF 01 53 01 CF

HDMI rear 3	7F 08 99 A2 B3 C4 02 FF 01 54 CF	7F 09 99 A2 B3 C4 02 FF 01 54 01 CF
HDMI rear 4	7F 08 99 A2 B3 C4 02 FF 01 55 CF	7F 08 99 A2 B3 C4 02 FF 01 55 01 CF
VOL -	7F 08 99 A2 B3 C4 02 FF 01 17 CF	7F 09 99 A2 B3 C4 02 FF 01 17 01 CF
VOL +	7F 08 99 A2 B3 C4 02 FF 01 18 CF	7F 09 99 A2 B3 C4 02 FF 01 18 01 CF
Menu	7F 08 99 A2 B3 C4 02 FF 01 1B CF	7F 09 99 A2 B3 C4 02 FF 01 1B 01 CF
Return (exit)	7F 08 99 A2 B3 C4 02 FF 01 1D CF	7F 09 99 A2 B3 C4 02 FF 01 1D 01 CF
OK	7F 08 99 A2 B3 C4 02 FF 01 2B CF	7F 09 99 A2 B3 C4 02 FF 01 2B 01 CF
←	7F 08 99 A2 B3 C4 02 FF 01 2C CF	7F 09 99 A2 B3 C4 02 FF 01 2C 01 CF
→	7F 08 99 A2 B3 C4 02 FF 01 2D CF	7F 09 99 A2 B3 C4 02 FF 01 2D 01 CF
↑	7F 08 99 A2 B3 C4 02 FF 01 2E CF	7F 09 99 A2 B3 C4 02 FF 01 2E 01 CF
↓	7F 08 99 A2 B3 C4 02 FF 01 2F CF	7F 09 99 A2 B3 C4 02 FF 01 2F 01 CF
Set volume	7F 08 99 A2 B3 C4 02 FF 05 XX CF NOTE: XX indicates the volume value (0 to 100), corresponding to hexadecimals 00 to 64.	7F 09 99 A2 B3 C4 02 FF 05 XX 01 CF
Query the firmware version number	7F 08 99 A2 B3 C4 02 FF 01 3D CF	7F 09 99 A2 B3 C4 02 FF 01 3D 01 CF
Set display mode	7F 08 99 A2 B3 C4 02 FF 06 XX CF NOTE: XX indicates the mode... 00- standard, 01-ECO mode, 02- custom, 03-auto	7F 09 99 A2 B3 C4 02 FF 06 XX 01 CF
Microphone mute toggle	7F 08 99 A2 B3 C4 02 FF 01 41 CF	7F 09 99 A2 B3 C4 02 FF 01 41 01 CF
Microphone Mute On	7F 09 99 A2 B3 C4 02 FF 0C 01 CF	7F 09 99 A2 B3 C4 02 FF 0C 01 01 CF
Microphone Mute Off	7F 09 99 A2 B3 C4 02 FF 0C 02 CF	7F 09 99 A2 B3 C4 02 FF 0C 02 01 CF



Increase backlight brightness	7F 08 99 A2 B3 C4 02 FF 01 47 CF	7F 09 99 A2 B3 C4 02 FF 01 47 01 CF
Decrease backlight brightness	7F 08 99 A2 B3 C4 02 FF 01 48 CF	7F 09 99 A2 B3 C4 02 FF 01 48 01 CF
Set the value of backlight brightness	7F 08 99 A2 B3 C4 02 FF 09 XX CF NOTE: XX indicates the value of backlight brightness (0 - 100), corresponding to the hexadecimal number system (00 - 64).	7F 09 99 A2 B3 C4 02 FF 09 XX 01 CF
Switch backlight	7F 08 99 A2 B3 C4 02 FF 01 15 CF	7F 09 99 A2 B3 C4 02 FF 01 15 XX CF NOTE: XX = 01 indicates the backlight is on. XX = 00 indicates the backlight is off.
Switch Backlight On	7F 09 99 A2 B3 C4 02 FF 0E 01 CF	7F 09 99 A2 B3 C4 02 FF 0E 01 01 CF
Switch Backlight Off	7F 09 99 A2 B3 C4 02 FF 0E 00 CF	7F 09 99 A2 B3 C4 02 FF 0E 00 01 CF
Settings	7F 08 99 A2 B3 C4 02 FF 01 20 CF	7F 09 99 A2 B3 C4 02 FF 01 20 01 CF
Freeze ON/OFF toggle	7F 08 99 A2 B3 C4 02 FF 01 3B CF	7F 09 99 A2 B3 C4 02 FF 01 3B 01 CF
Freeze On	7F 09 99 A2 B3 C4 02 FF 0B 00 CF	7F 09 99 A2 B3 C4 02 FF 0B 00 01 CF
Freeze Off	7F 09 99 A2 B3 C4 02 FF 0B 01 CF	7F 09 99 A2 B3 C4 02 FF 0B 01 01 CF
Activate Newline Cast	7F 08 99 A2 B3 C4 02 FF 00 0D CF	7F 09 99 A2 B3 C4 02 FF 00 0D 01 CF
Close Newline Cast	7F 08 99 A2 B3 C4 02 FF 01 0D CF	7F 09 99 A2 B3 C4 02 FF 01 0D 01 CF
Activate Newline Broadcast	7F 08 99 A2 B3 C4 02 FF 00 0F CF	7F 09 99 A2 B3 C4 02 FF 00 1F 01 CF
Close Newline Broadcast	7F 08 99 A2 B3 C4 02 FF 01 0F CF	7F 09 99 A2 B3 C4 02 FF 01 1F 01 CF
Sleep	7F 08 99 A2 B3 C4 02 FF 01 51 CF	7F 09 99 A2 B3 C4 02 FF 01 51 01 CF
Home source	7F 08 99 A2 B3 C4 02 FF 01 1C CF	7F 09 99 A2 B3 C4 02 FF 01 1C 01 CF

# 7

## Formats Supported by Multi-media

---

Media category	Formats
Photo	JPEG, BMP, PNG
Movie	AVS, AVS+, AVS2.0, H263, H264, H265, H265 (V811only), MPEG-1, MPEG-2, MPEG-4, MPEG-4
Music	AAC , AC4, ADPCM, APE, DRA, FLAC, MID, MPEG, PCM, TrueHD, Vorbis

# 8 FAQ & Troubleshooting

---

Before you contact the technical support staff, please identify a fault according to the following table. If the fault cannot be restored based on the solutions, contact the local distributor for help. For your safety, please do not repair the machine by your own.

Failure	Possible Cause	Solution
The service program fails to be connected.	The drive program is not correctly installed.	Install the drive program correctly.
	The USB port (lead) is not connected or is faulty.	Change the USB lead or check if the USB port is faulty.
	The infrared tube is blocked.	Ensure that the surrounding infrared tubes are not blocked.
Repositioning is required every time the panel is switched on.	The computer is equipped with a recovery card.	Disable computer protection and perform the positioning again.
The calibration is inaccurate.	The positioning is not performed properly.	Press <b>AUTO</b> on the remote controller to show the full screen, and use the pen provided with the panel to perform positioning again.
Not sound and image	<ul style="list-style-type: none"> <li>• Check whether the power plug is inserted into the power outlet and whether the panel is powered on.</li> <li>• Check whether the rocker switch on the machine is switched on.</li> <li>• Check whether the power button on the panel is pressed.</li> <li>• Check whether the video and audio input cables are connected correctly.</li> <li>• Check whether the panel is switched to the right signal source.</li> <li>• Check the settings on image brightness and contrast.</li> <li>• Check the volume.</li> </ul>	
Image is normal, but no sound	<ul style="list-style-type: none"> <li>• Check the volume.</li> <li>• Check whether the <b>MUTE</b> button on the remote controller is pressed.</li> <li>• Check whether the audio cable between the PC and the machine is connected correctly.</li> </ul>	

Failure	Possible Cause	Solution
No image or the image is black and white	<ul style="list-style-type: none"> <li>• Modify the color settings.</li> <li>• Check the color system.</li> </ul>	
Image or sound is interrupted	<ul style="list-style-type: none"> <li>• Find out the electric appliance that causes the interference and move it away from the machine.</li> <li>• Do not share the power socket of the panel with the electric appliance that causes interference.</li> </ul>	
The remote controller fails	<ul style="list-style-type: none"> <li>• Change the batteries.</li> <li>• Clean the signal emitter at the top of the remote controller. (Check whether it is blocked.)</li> <li>• Check contacts of the batteries.</li> </ul>	
Computer cannot be started (applicable for models with computers)	<ul style="list-style-type: none"> <li>• Check whether the PC adapter is correctly connected and whether the PC is powered on.</li> <li>• Check whether the PC is connected correctly to the machine.</li> </ul>	

The following symptoms are not faults:

- A very few of constantly bright or dark pixels, such as tiny red, blue, green or dark points, may exist on the LED. This symptom is not a fault and does not affect running functions of the machine.
- Slight sound may occur due to the backlight adjustment or ventilation. This is a normal symptom.
- The image and sound are normal. However, you can sense static electricity when you touch the LED and metal back cover. This is a normal symptom.

# 9 Maintenance Tips

---

- Do not install or place the machine near the heat source.
- Do not install or place the machine under directly sunlight, or dust /damp place.
- Do not install or place the machine in the places with mechanical vibration and vulnerable to impact.
- Please keep the machine stay away from grid, large metal objects, radar stations and other equipment.
- Do not use chemical reagents to wipe the machine body, solvent may cause deterioration or damage to the shell paint. If have dirt bilge, wipe it with drying warm cloth after cutting off power source. Display touch screen can be wiped gently with a clean soft cloth.
- Do not power on and off the machine frequently, so as not to affect the service life of the machine. After normal shutdown, please wait three minutes before starting up. If not in use for a long time, please turn off the power and unplug the machine.
- Do not set the display brightness and contrast to the maximum for a long time to extend the service life of the LED.
- Do not use hard objects to write on the touch screen, so as not to scratch the screen and affect the display effect.

# 10 Technical Parameters

---

Specification	85"	98"
Backlight type	LCD	LCD
External dimension (bare machine)	1967x1152x87/109/122mm	2212.3*1292.9*93.2mm
Aspect ratio	16:9	16:9
Viewing angle	178°	178°
Physical resolution	3840 × 2160 Pixel	3840 × 2160 Pixel
Display color	RGB	RGB
Display contrast	3200:1 min, 4000:1 type	900:1 (min) , 1200: 1 (type)
Rated Voltage	AC 100~240V	AC 100~240V
Standby power consumption	≤0.5W	≤0.5W
Rated power	450W	≤700W
Rated frequency	50 ± 5%Hz, 60 ± 5%Hz	50 ± 5%Hz, 60 ± 5%Hz
Color Temp	8500-12000K	8500-12000K
Color range	Min80%, TYP:85%	Min80%, TYP:85%
Luminance uniformity	TYP:80% Min:75%	TYP:80% Min:75%
Communication interface	USB+ UART	USB+ UART
Storage temperature/humidity	-15 °C ~55 °C , 20~90%RH (no condensation)	-15 °C ~55 °C , 20~90%RH (no condensation)
Working temperature/humidity	0 °C~40 °C, 20~80%RH (no condensation)	0 °C~40 °C, 20~80%RH (no condensation)
Installation method	Wall-mount or Stand	Wall-mount or Stand
Net weight	46.5 ± 2Kg	80 ± 2kg
Gross weight	64.5 ± 2kg	133 ± 2kg

# 11 More Information

---

## **For More Information**

Please visit our website ([www.newline-interactive.com](http://www.newline-interactive.com)) for detailed instruction manual.

## **Contact Us for Support**

Please email us at [support@newline-interactive.com](mailto:support@newline-interactive.com).

Our company is devoted to machine innovation and technology enhancement. Therefore, we may change machine specs and information without notice, Machine pictures in the manual are for reference only, please refer to actual machines.